

RESISTORS 120 OHM J1 DISPLAY

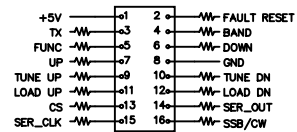

RESISTORS 120 OHM J4 REMOTE

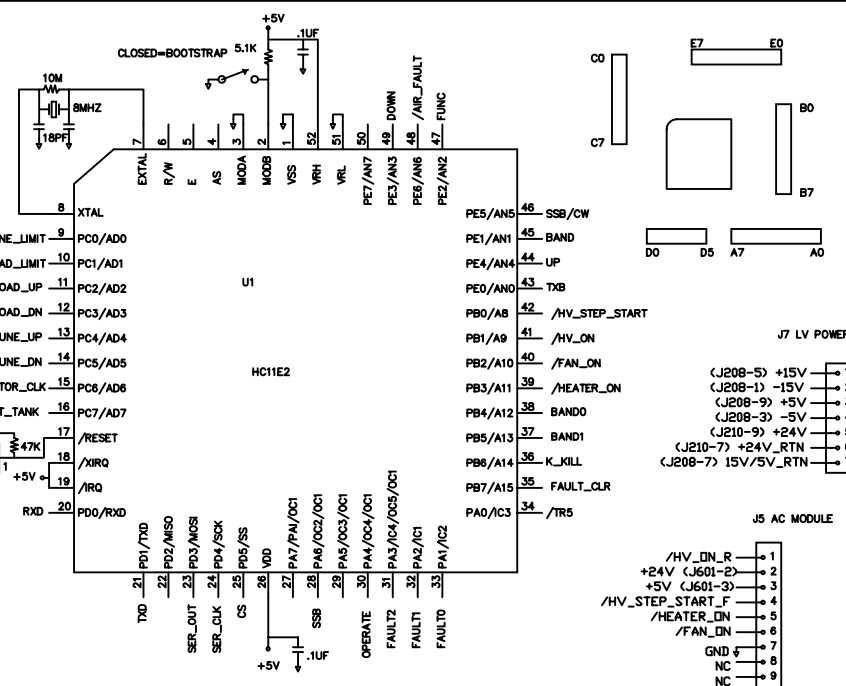
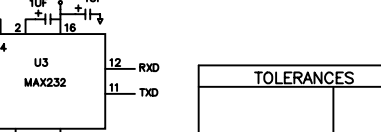
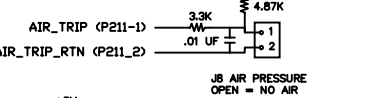
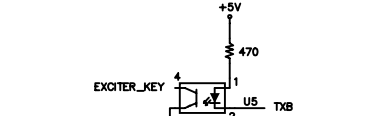
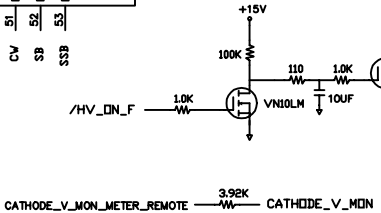
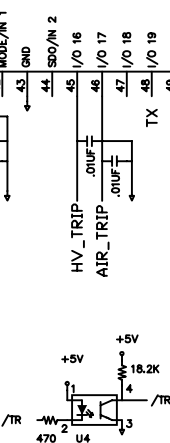
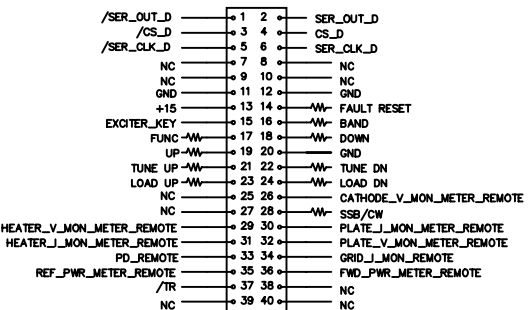

J6 CATHODE BOARD

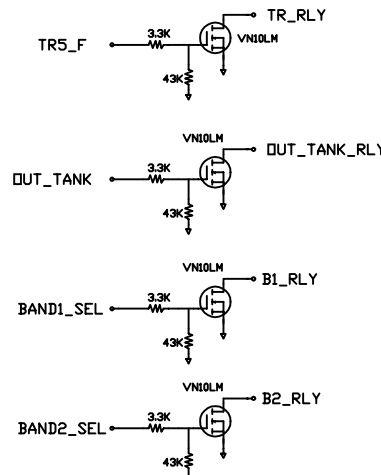
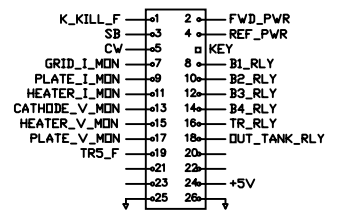

TOLERANCES	SCALE 1-1	DO NOT SCALE	FINISH	DRAWN BY 16 MAY 2002	DATE
	MATERIAL			CHECKED BY	DATE
TITLE YC156 AMP HC11, CPLD				DWG SZ A	SHEET 1 OF 1
				DRAWING NUMBER CONTROL BOARD 1 SCH.DWG	REV